

Interchangeable Lens Digital Camera

α58

Instruction Manual

A-mount

Preparing the camera

Shooting and viewing
images

Shooting images to suit
your subject

Using the shooting
functions

Using the playback
functions

Function list

Viewing images on a
computer

Others

Index

α

SonyAlpha.info

English

Owner's Record

The model and serial numbers are located on the bottom. Record the serial number in the space provided below. Refer to these numbers whenever you call your Sony dealer regarding this product.

Model No. SLT-A58

Serial No. _____

WARNING

To reduce fire or shock hazard, do not expose the unit to rain or moisture.

IMPORTANT SAFETY INSTRUCTIONS -SAVE THESE INSTRUCTIONS DANGER TO REDUCE THE RISK OF FIRE OR ELECTRIC SHOCK, CAREFULLY FOLLOW THESE INSTRUCTIONS

If the shape of the plug does not fit the power outlet, use an attachment plug adaptor of the proper configuration for the power outlet.

CAUTION

Battery pack

If the battery pack is mishandled, the battery pack can burst, cause a fire or even chemical burns. Observe the following cautions.

- Do not disassemble.
- Do not crush and do not expose the battery pack to any shock or force such as hammering, dropping or stepping on it.
- Do not short circuit and do not allow metal objects to come into contact with the battery terminals.
- Do not expose to high temperature above 60°C (140°F) such as in direct sunlight or in a car parked in the sun.
- Do not incinerate or dispose of in fire.
- Do not handle damaged or leaking lithium ion batteries.
- Be sure to charge the battery pack using a genuine Sony battery charger or a device that can charge the battery pack.
- Keep the battery pack out of the reach of small children.
- Keep the battery pack dry.
- Replace only with the same or equivalent type recommended by Sony.
- Dispose of used battery packs promptly as described in the instructions.

Battery charger

Even if the CHARGE lamp is not lit, the battery charger is not disconnected from the AC power source (mains) as long as it is connected to the wall outlet (wall socket).

If some trouble occurs while using the battery charger, immediately shut off the power by disconnecting the plug from the wall outlet (wall socket).

For Customers in the U.S.A. and Canada

RECYCLING LITHIUM-ION BATTERIES

Lithium-Ion batteries
are recyclable.

You can help preserve
our environment by
returning your used
rechargeable batteries
to the collection and
recycling location
nearest you.



For more information regarding recycling
of rechargeable batteries, call toll free
1-800-822-8837, or visit
<http://www.rbrclion.org/>

Caution: Do not handle damaged or
leaking Lithium-Ion batteries.

Battery pack and lens (if lens supplied)

This device complies with Part 15 of the
FCC Rules. Operation is subject to the
following two conditions:

(1) This device may not cause harmful
interference, and (2) this device must
accept any interference received, including
interference that may cause undesired
operation.

CAN ICES-3 B/NMB-3 B

For Customers in the U.S.A.

UL is an internationally recognized safety
organization.

The UL Mark on the product means it has
been UL Listed.

If you have any questions about this
product, you may call:

Sony Customer Information Center
1-800-222-SONY (7669).

The number below is for the FCC related
matters only.

Regulatory Information

Declaration of Conformity

Trade Name: SONY

Model No.: SLT-A58

Responsible Party: Sony Electronics
Inc.

Address: 16530 Via Esprillo,
San Diego, CA
92127 U.S.A.

Telephone No.: 858-942-2230

This device complies with Part 15 of the
FCC Rules. Operation is subject to the
following two conditions: (1) This
device may not cause harmful
interference, and (2) this device must
accept any interference received,
including interference that may cause
undesired operation.

CAUTION

You are cautioned that any changes or
modifications not expressly approved in
this manual could void your authority to
operate this equipment.

Note:

This equipment has been tested and found to comply with the limits for a Class B digital device, pursuant to Part 15 of the FCC Rules.

These limits are designed to provide reasonable protection against harmful interference in a residential installation. This equipment generates, uses, and can radiate radio frequency energy and, if not installed and used in accordance with the instructions, may cause harmful interference to radio communications.

However, there is no guarantee that interference will not occur in a particular installation. If this equipment does cause harmful interference to radio or television reception, which can be determined by turning the equipment off and on, the user is encouraged to try to correct the interference by one or more of the following measures:

- Reorient or relocate the receiving antenna.
- Increase the separation between the equipment and receiver.
- Connect the equipment into an outlet on a circuit different from that to which the receiver is connected.
- Consult the dealer or an experienced radio/TV technician for help.

The supplied interface cable must be used with the equipment in order to comply with the limits for a digital device pursuant to Subpart B of Part 15 of FCC Rules.

For Customers in Europe

Notice for the customers in the countries applying EU Directives

This product has been manufactured by or on behalf of Sony Corporation, 1-7-1 Konan Minato-ku Tokyo, 108-0075 Japan. Inquiries related to product compliance based on European Union legislation shall be addressed to the authorized representative, Sony Deutschland GmbH, Hedelfinger Strasse 61, 70327 Stuttgart, Germany. For any service or guarantee matters, please refer to the addresses provided in the separate service or guarantee documents.

This product has been tested and found compliant with the limits set out in the EMC regulation for using connection cables shorter than 3 meters (9.8 feet).

Attention

The electromagnetic fields at the specific frequencies may influence the picture and sound of this unit.

Notice

If static electricity or electromagnetism causes data transfer to discontinue midway (fail), restart the application or disconnect and connect the communication cable (USB, etc.) again.

Disposal of Old Electrical & Electronic Equipment (Applicable in the European Union and other European countries with separate collection systems)



This symbol on the product or on its packaging indicates that this product shall not be treated as household waste. Instead it shall be handed over to the applicable collection point for the recycling of

electrical and electronic equipment. By ensuring this product is disposed of correctly, you will help prevent potential negative consequences for the environment and human health, which could otherwise be caused by inappropriate waste handling of this product. The recycling of materials will help to conserve natural resources. For more detailed information about recycling of this product, please contact your local Civic Office, your household waste disposal service or the shop where you purchased the product.

Disposal of waste batteries (applicable in the European Union and other European countries with separate collection systems)



This symbol on the battery or on the packaging indicates that the battery provided with this product shall not be treated as household waste.

On certain batteries this symbol might be used in combination with a chemical symbol. The chemical symbols for mercury (Hg) or lead (Pb) are added if the battery contains more than 0.0005% mercury or 0.004% lead.

By ensuring these batteries are disposed of correctly, you will help prevent potentially negative consequences for the environment and human health which could otherwise be caused by inappropriate waste handling of the battery. The recycling of the materials will help to conserve natural resources. In case of products that for safety, performance or data integrity reasons require a permanent connection with an incorporated battery, this battery should be replaced by qualified service staff only. To ensure that the battery will be treated properly, hand over the product at end-of-life to the applicable collection point for the recycling of electrical and electronic equipment.



For all other batteries, please view the section on how to remove the battery from the product safely.

Hand the battery over to the applicable collection point for the recycling of waste batteries.

For more detailed information about recycling of this product or battery, please contact your local Civic Office, your household waste disposal service or the shop where you purchased the product.

Notice for customers in the United Kingdom

A moulded plug complying with BS 1363 is fitted to this equipment for your safety and convenience.

Should the fuse in the plug supplied need to be replaced, a fuse of the same rating as the supplied one and approved by ASTA or BSI to BS 1362, (i.e., marked with an  or  mark) must be used.

If the plug supplied with this equipment has a detachable fuse cover, be sure to attach the fuse cover after you change the fuse. Never use the plug without the fuse cover. If you should lose the fuse cover, please contact your nearest Sony service station.

Table of Contents

Notes on using your camera	10
----------------------------------	----



Preparing the camera

Checking the supplied items	12
Identifying parts	13
Front	13
Back	14
Top	15
Sides/Bottom	16
Lens	18
Charging the battery pack	19
Inserting the battery pack/memory card (sold separately)	21
Memory cards that you can use	23
Attaching a lens	24
Turning on the camera and setting the clock	27
Before shooting	29
Adjusting the viewfinder's visual acuity (diopter adjustment).....	29
Holding the camera properly	29



Shooting and viewing images

Shooting still images	30
Recording movies	32
Playing back images	33
Deleting images (Delete)	34

Shooting images to suit your subject

Adjusting the angle of the LCD screen	35
Selecting a shooting mode	36
 Superior Auto	37
SCN Scene Selection	38
 Sweep Panorama	39
 Tele-zoom Cont. Priority AE	40

Using the shooting functions

Using the flash	41
Adjusting the image brightness	43
 /  Selecting the drive mode	45
Switching the recording information display (DISP)	46
Setting image size	47
Image Size	47
Panorama: Size	47

Using the playback functions

Enlarging images	48
Switching to the image list display	49
Viewing images on a TV screen	50

Function list

Functions that can be operated using the buttons/switch	51
Selecting a function using the Fn (Function) button	52
Functions that can be selected using the Fn (Function) button	53
Functions selected using the MENU button	55
Using the guide function of the camera	62
In-Camera Guide	62
Shooting Tips	62

Viewing images on a computer

What you can do with software	64
What you can do with “PlayMemories Home”	64
What you can do with “Image Data Converter”	65
Installing the software	66
Installing “PlayMemories Home”	66
Viewing “PlayMemories Home Help Guide”	66
Installing “Image Data Converter”	67
Viewing “Image Data Converter Guide”	67
Installing “Remote Camera Control”	68
Selecting the method for creating a movie disc	69
Creating a disc using a computer	70
Creating a disc with a device other than a computer	70

Others

List of screen icons	71
Functions available for each shooting mode	74
Flash modes available	75
Learning more about the camera (<i>α</i> Handbook)	76
Checking the number of recordable images/ recording time	77
Specifications	81
Index	90

Notes on using your camera

Shooting procedure

This camera has 2 modes for monitoring subjects: an LCD screen mode using the LCD screen, and a viewfinder mode using the viewfinder.

Notes on the functions available with the camera

To check whether it is a 1080 60i-compatible device or 1080 50i-compatible device, check for the following marks on the bottom of the camera.

1080 60i-compatible device: 60i

1080 50i-compatible device: 50i

No compensation for recorded content

The recorded content cannot be compensated for if recording or playback is not possible due to a malfunction of your camera or memory card, etc.

Back up recommendation

To avoid the risk of data loss, always copy (back up) data to other media.

Notes on the LCD screen, electronic viewfinder, lens, and image sensor

- The LCD screen and electronic viewfinder are manufactured using extremely high-precision technology, so over 99.99% of the pixels are operational for effective use. However, there may be some tiny black points and/or bright points (white, red, blue or green in color) that constantly appear on the LCD screen and electronic viewfinder. These points are normal in the manufacturing process and do not affect the images in any way.
- Do not hold the camera by the LCD screen.

- Do not expose the camera to sunlight or shoot toward the sun for extended periods of time. The internal mechanism may be damaged. If reflected sunlight is focused on a nearby object, it may cause a fire.
- There is a magnet on the back and around the rotating shaft of the hinge of the LCD screen. Do not bring anything that is easily affected by a magnet, such as floppy disks or credit cards, near the LCD screen.
- Images may trail across on the screen in cold locations. This is not a malfunction. When turning on the camera in a cold location, the screen may become temporarily dark. When the camera warms up, the screen will function normally.
- The recorded image may differ from the image you monitor before recording.

Notes on recording over extended periods of time

- When you continue to shoot for a long time, the temperature of the camera rises. If the temperature reaches a certain level, the [D] icon appears on the screen and the camera turns off automatically. If the power is turned off, leave the camera for 10 minutes or longer to allow the temperature inside the camera to decrease to a safe level.
- Under high ambient temperatures, the temperature of the camera rises quickly.
- When the temperature of the camera rises, the image quality may deteriorate. We recommend that you wait until the temperature of the camera drops before continuing to shoot.
- The surface of the camera may grow warm. This is not a malfunction.

Notes on importing AVCHD movies to a computer

When importing AVCHD movies to a computer, for Windows computers, use the “PlayMemories Home” software.

Notes on playing movies on other devices

- This camera uses MPEG-4 AVC/H.264 High Profile for AVCHD format recording. Movies recorded in AVCHD format on this camera cannot be played using the following devices.
 - Other devices compatible with AVCHD format that do not support High Profile
 - Devices incompatible with the AVCHD format
 This camera also uses MPEG-4 AVC/H.264 Main Profile for MP4 format recording. For this reason, movies recorded in MP4 format on this camera cannot be played on devices other than those that support MPEG-4 AVC/H.264.
- Discs recorded in HD image quality (high definition) can be played back only on AVCHD format-compatible devices. DVD-based players or recorders cannot play back HD image quality discs, as they are incompatible with the AVCHD format. Also, DVD-based players or recorders may fail to eject HD image quality discs.

Warning on copyright

Television programs, films, videotapes, and other materials may be copyrighted. Unauthorized recording of such materials may be contrary to the provisions of copyright laws.

The pictures used in this manual

The photographs used as examples of pictures in this manual are reproduced images, and are not actual images shot using this camera.

On the data specifications described in this manual

The data on performance and specifications are defined under the following conditions, except as described in this manual: at an ordinary ambient temperature of 25°C (77°F), and using a battery pack that has been fully charged for about an hour after the charge lamp has turned off.

Model name

This manual covers several models supplied with different lenses. The model name varies depending on the supplied lens. The available model varies depending on the country/region.

Model name	Lens
SLT-A58K	DT18-55mm
SLT-A58M	DT18-135mm
SLT-A58Y	DT18-55mm and DT55-200mm

Checking the supplied items

First check the model name of your camera (page 11). The accessories supplied differ depending on the model.

The number in parentheses indicates the quantity.

Supplied with all models

- Camera (1)
- Battery charger BC-VM10A (1)

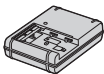

- Power cord (mains lead) (1)* (not supplied in the U.S.A. and Canada)



* Multiple power cords may be supplied with your camera. Use the appropriate one that matches your country/region.

- Rechargeable battery pack NP-FM500H (1)



- Micro USB cable (1)

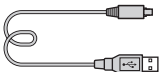

- Shoulder strap (1)

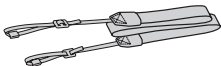

- Body cap (1) (Attached to the camera)



- Eyepiece cup (1) (Attached to the camera)
- Instruction Manual (This manual) (1)

SLT-A58K

- DT18-55mm zoom lens (1)/Front lens cap (1)/Packaging lid (1)

SLT-A58M

- DT18-135mm zoom lens (1)/Front lens cap (1)/Rear lens cap (1)/Lens hood (1)

SLT-A58Y

- DT18-55mm zoom lens (1)/Front lens cap (1)/Packaging lid (1)
- DT55-200mm zoom lens (1)/Front lens cap (1)/Rear lens cap (1)/Lens hood (1)

Identifying parts

See the pages in parentheses for details on operation for the parts.

Front

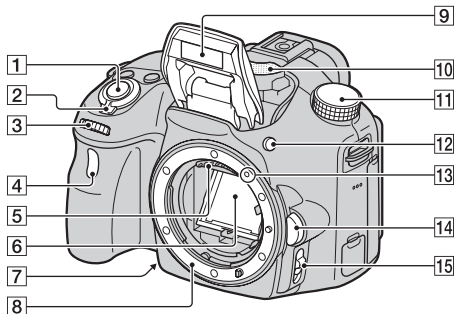

1 Shutter button (30)

2 Power switch (27)

3 Control dial (33, 36)

4 Self-timer lamp (45)

5 Lens contacts*

6 Mirror*

- This mirror is made of a transmissive film. Do not touch the mirror. Doing so may soil or deform the mirror, and the image quality and camera performance may deteriorate.

7 Preview button (51)/Focus Magnifier button (51)

8 Mount

9 Built-in flash* (41)

10 Microphone**

11 Mode dial (36)

12 ⚡ (Flash pop-up) button (41)

13 Mounting index (24)

14 Lens release button (25)





15 Focus mode switch (51)

* **Do not directly touch these parts.**

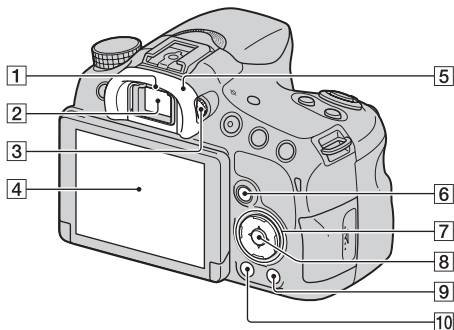
** **Do not cover this part during movie recording. Doing so may cause noise or lower the volume.**

Back





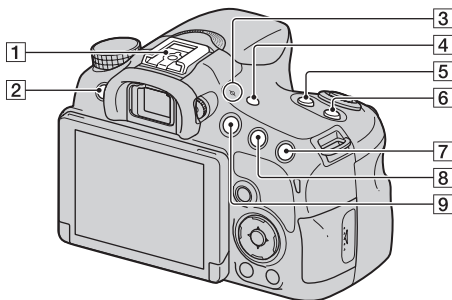

- 1** Eyepiece sensors
- 2** Viewfinder*
- When you look into the viewfinder, viewfinder mode is activated, and when you move your face away from the viewfinder, viewing mode returns to LCD screen mode.
- 3** Diopter-adjustment dial (29)
- 4** LCD screen (71)
- 5** Eyepiece cup
- 6** For shooting: Fn (Function) button (52, 53)
For viewing:  (Image rotation) button (51)
- 7** Control button
▲/▼/◀/▶/DISP (Display Contents) (46)/WB (White Balance) (54)/ (Drive Mode) (45)/ (Picture Effect) (54)
- 8** Control button (Enter)/AF button (53)/Lock-on AF button (53)
- 9** ? (In-Camera Guide) button (62)
For viewing:  (Delete) button (34)
- 10**  (Playback) button (33)

* **Do not directly touch this part.**

Top



- 1 Multi interface shoe¹⁾²⁾
- 2 MENU button (55)
- 3  Image sensor position mark
- 4 FINDER/LCD button (51)
- 5 ZOOM button (51)
- 6 ISO button (51)
- 7 For shooting:  (Exposure) button (43)/AV (Aperture value) button (51)
For viewing:  (Zoom in) button (48)
- 8 For shooting: AEL (AE lock) button (51)
For viewing:  (Zoom out) button (48)/ (Image index) button (49)
- 9 MOVIE button (32)

- ¹⁾ For details on compatible accessories for the Multi interface shoe, visit the Sony web site, or consult a Sony dealer or local authorized Sony service facility in your area. Accessories for the Accessory Shoe can also be used. Operation with other manufactures' accessories is not guaranteed.

Multi Interface Shoe

Accessory Shoe

- ²⁾ Accessories for the Auto-lock Accessory Shoe can also be attached using the Shoe Adaptor (sold separately).

Auto-lock Accessory Shoe

Sides/Bottom

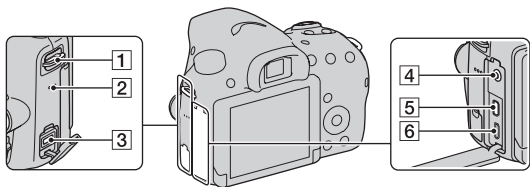
**1** Hooks for shoulder strap

- Attach both ends of the strap to the camera.

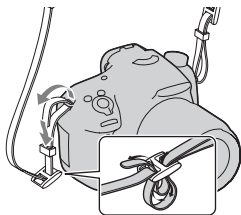
**2** Speaker**3** DC IN terminal

- When connecting the AC-PW10AM AC Adaptor (sold separately) to the camera, turn the camera off, then plug the connector of the AC Adaptor into the DC IN terminal on the camera.

4 (Microphone) jack

- When an external microphone is connected, the internal microphone is automatically turned off. If the external microphone is a plug-in-power type, the power of the microphone is supplied by the camera.

5 HDMI micro jack (50)**6** Multi/Micro USB Terminal (66)

- Supports Micro USB compatible device.

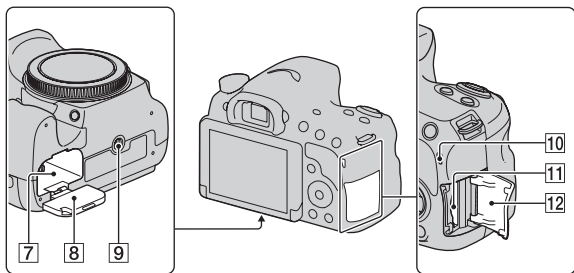

- 7** Battery insertion slot (21)
- 8** Battery cover (21)
- 9** Tripod receptacle
 - Use a tripod with a screw length of less than 5.5 mm (7/32 inch). You will be unable to firmly secure the camera to tripods with a screw length of 5.5 mm (7/32 inch) or longer, and attempting to do so may damage the camera.
- 10** Access lamp (22)
- 11** Memory card insertion slot (21)
- 12** Memory card cover (21)

Lens

DT 18-55mm F3.5-5.6 SAM II (Supplied with the SLT-A58K/ A58Y)

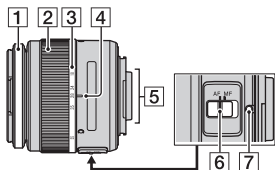

DT 55-200mm F4-5.6 SAM (Supplied with the SLT-A58Y)

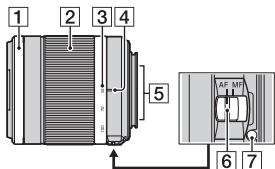

DT 18-135mm F3.5-5.6 SAM (Supplied with the SLT-A58M)

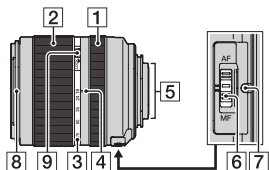

- 1 Focusing ring
- 2 Zoom ring
- 3 Focal-length scale
- 4 Focal-length index
- 5 Lens contacts
- 6 Focusing mode switch
- 7 Mounting index
- 8 Lens hood index
- 9 Zoom lock switch

- The DT 18-55mm F3.5-5.6 SAM II/DT 55-200mm F4-5.6 SAM/DT 18-135mm F3.5-5.6 SAM are designed for Sony A-mount cameras (models equipped with an APS-C sized image sensor). You cannot use these lenses on 35mm-format cameras.
- For lenses other than DT 18-55mm F3.5-5.6 SAM II/DT 55-200mm F4-5.6 SAM/DT 18-135mm F3.5-5.6 SAM, refer to the operating instructions supplied with the lens.

Charging the battery pack

When using the camera for the first time, be sure to charge the NP-FM500H “InfoLITHIUM” battery pack (supplied).

The “InfoLITHIUM” battery pack can be charged even when it has not been fully depleted. The battery pack can also be used when it has not been fully charged.

The charged battery pack is discharged little by little, even when you do not use it. To avoid missing an opportunity to shoot, charge the battery pack again before you shoot.

1 Insert the battery pack into the battery charger.

Push the battery pack in until it clicks.

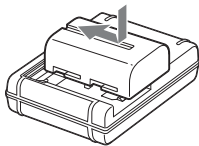

2 Connect the battery charger to a wall outlet (wall socket).

Light on: Charging

Light off: Charge completed

Charging time	About 175 minutes
---------------	-------------------

- When charging a fully depleted battery pack at a temperature of 25°C (77°F).
- The CHARGE lamp turns off when charging is completed.

For the U.S.A. and Canada

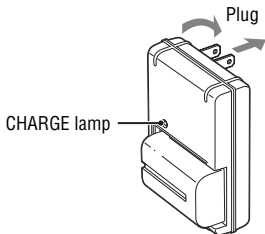

For countries/regions other than the U.S.A. and Canada

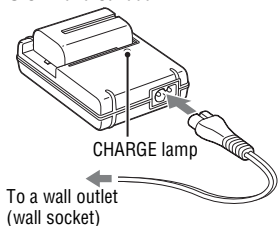

Notes

- The charging time differs depending on the remaining capacity of the battery pack or charging conditions.
- We recommend charging the battery pack in an ambient temperature of between 10°C to 30°C (50°F to 86°F). You may not be able to efficiently charge the battery pack outside of this temperature range.
- Connect the battery charger to the nearest wall outlet (wall socket).

Inserting the battery pack/memory card (sold separately)

- 1 Open the battery cover by sliding the lever.

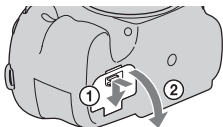

- 2 Insert the battery pack completely, using the tip of the battery to press the lock lever.

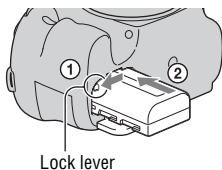

- 3 Close the cover.

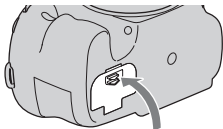

- 4 Slide and open the memory card cover.

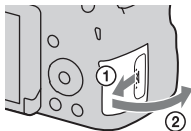

5 Insert a memory card.

- With the notched corner facing in the direction shown, insert the memory card until it clicks into place.

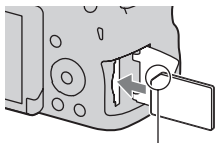

Ensure that the notched corner faces the correct direction.

6 Close the cover.

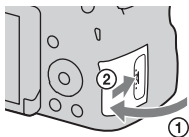

To remove the battery pack

Turn off the camera and check that the vibration of the camera has stopped and that both the LCD screen and access lamp (page 17) are turned off. Then, slide the lock lever in the direction of the arrow to remove the battery pack. Be careful not to drop the battery pack.

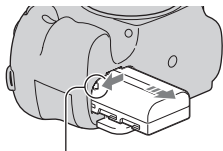

Lock lever

To remove the memory card

Make sure that the access lamp is not lit, then open the cover and push the memory card once.

To check the remaining battery level

The supplied battery pack is a lithium-ion battery pack that can exchange information related to operating conditions with your camera. The remaining battery time in percent figures is displayed according to the operating conditions of your camera.

Battery level						“Battery exhausted.”
	High Low					You cannot shoot any more pictures.

Memory cards that you can use

The following memory cards are compatible with this camera. However, all memory cards are not guaranteed to work with this camera.

Types of memory card	Still images	Movies	In this manual
Memory Stick PRO Duo	✓	✓ (Mark2)	Memory Stick PRO Duo
Memory Stick PRO-HG Duo	✓	✓	
Memory Stick XC-HG Duo	✓	✓	Memory Stick XC Duo
SD memory card	✓	✓ (Class 4 or faster)	SD card
SDHC memory card	✓	✓ (Class 4 or faster)	
SDXC memory card	✓	✓ (Class 4 or faster)	

Notes

- Images recorded on a “Memory Stick XC-HG Duo” media or an SDXC memory card cannot be imported to or played on computers or AV devices that are not compatible with exFAT. Make sure that the device is compatible with exFAT before connecting it to the camera. If you connect your camera to an incompatible device, you may be prompted to format the card. Never format the card in response to this prompt, as doing so will erase all data on the card. (exFAT is the file system used on “Memory Stick XC-HG Duo” media or SDXC memory cards.)

Attaching a lens

1 Remove the body cap from the camera and the packaging lid from the rear of the lens.

- Quickly change the lens somewhere away from dusty locations so as to keep dust or debris from getting inside the camera.
- When shooting, remove the front lens cap from the lens.

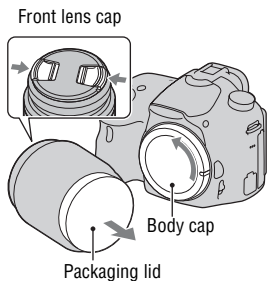

2 Mount the lens by aligning the orange index marks (mounting indexes) on the lens and camera.

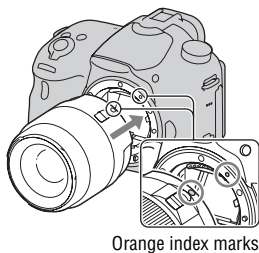

3 Turn the lens clockwise until it clicks into the locked position.

- Be sure to put the lens on straight.

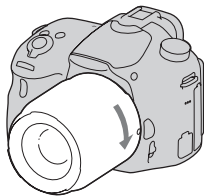

Notes

- When attaching a lens, do not press the lens release button.
- Do not use force when attaching a lens.
- E-mount lenses are not compatible with this camera.
- When using a lens equipped with a tripod socket, attach the socket on the lens side to the tripod to maintain balance.
- When carrying the camera with a lens attached, hold both the camera and the lens firmly.
- Do not hold the part of the lens that is extended for zoom or focus adjustments.

To remove the lens

- 1 Press the lens release button all the way in and turn the lens counterclockwise until it stops.**

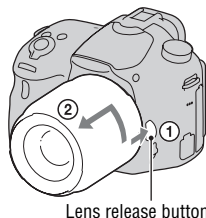

- 2 Attach the caps to the front and rear of the lens and the body cap to the camera.**

- Before you attach the caps, remove any dust.
- A rear lens cap is not supplied with the DT 18-55mm F3.5-5.6 SAM II Lens Kit. If storing the lens without attaching it to the camera, purchase Rear Lens Cap ALC-R55.

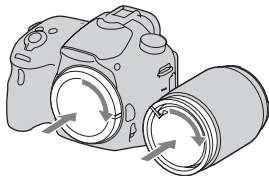

To attach a lens hood

It is recommended that you use a lens hood to reduce flare and ensure optimum image quality.

Fit the hood into the mount on the end of the lens barrel and rotate the hood clockwise until it clicks.

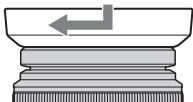

Notes

- A lens hood is not supplied with the DT 18-55mm F3.5-5.6 SAM II. You can use the ALC-SH108 (sold separately).
- The lens hood may block the light of the flash. Remove the lens hood when using the flash.
- When storing, turn over the lens hood and place it onto the lens backwards.

Note on changing the lens

When changing the lens, if dust or debris gets inside the camera and adheres to the surface of the image sensor (the part that converts light to electric signal), it may appear as dark spots on the image, depending on the shooting environment.

The image sensor is equipped with an anti-dust function to prevent dust from landing on the image sensor. However, attach or remove the lens quickly somewhere away from dusty locations.

Turning on the camera and setting the clock

When you turn on the camera for the first time, the date/time setup screen appears.

1 Set the power switch to ON to turn on the camera.

The screen to set date and time appears.

- To turn off the camera, set the power switch to OFF.

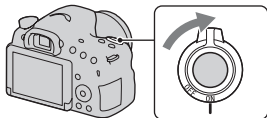

2 Check that [Enter] is selected on the LCD screen, then press the center of the control button.

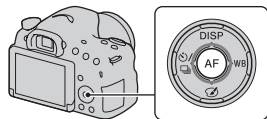

3 Select your area using ◀/▶ on the control button, then press the center of the control button.

4 Select each item using ◀/▶ and set the numeric value using ▲/▼.

[Daylight Svg.]: Turns on or off the daylight saving time setting.

[Date Format]: Selects the format for displaying the date.

- Midnight is indicated as 12:00 AM, and noon as 12:00 PM.

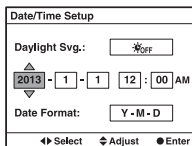
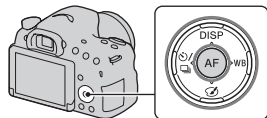

5 Repeat step 4 to set other items, then press the center of the control button.

6 Check that [Enter] is selected, then press the center of the control button.

To cancel the date/time setting operation

Press the MENU button.

To set the date/time again

The date/time setup screen appears automatically only when you turn the camera on for the first time. To set the date and time again, use the menu.

MENU button →  1 → [Date/Time Setup]

To set the area again

You can set the area where you are using the camera. This allows you to set the local area when you use the camera abroad.

MENU button →  1 → [Area Setting]

Maintaining the date and time setting

This camera has an internal rechargeable battery to maintain the date and time and other settings regardless of whether the power is on or off or the battery is installed.

Before shooting

Adjusting the viewfinder's visual acuity (diopter adjustment)

Adjust the diopter-adjustment dial to your eyesight until the display appears clearly in the viewfinder.

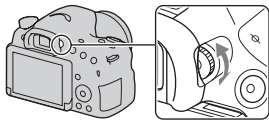

Notes

- The dioptic adjustment attachment (sold separately) cannot be used with this camera.

Holding the camera properly

Stabilize your upper body and take a position that keeps the camera from moving.

In LCD screen mode



In viewfinder mode



In viewfinder mode
(vertical position)



Point ①

Hold the camera with one hand, and support the lens with the other.

Point ②

Take a secure stance with your feet shoulder-width apart.

Point ③

Lightly tuck your elbows against your body. When shooting in a kneeling position, steady your upper body by placing your elbow on your knee.

Shooting still images

In [Intelligent Auto] mode, the camera analyzes the subject and allows you to shoot with the appropriate settings.

Select  when shooting in a location where flash use is restricted.

- 1 Set the mode dial to  (Intelligent Auto) or  (Flash Off).**

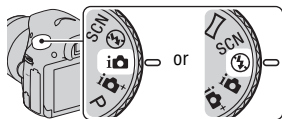

- 2 Hold the camera, monitoring your shot using the LCD screen or viewfinder.**

- 3 Overlay the AF area on the desired subject.**

- If the  (Camera shake warning) indicator flashes, carefully shoot the subject, holding the camera steady or using a tripod.
- When the camera recognizes the scene, the Scene Recognition icon appears on the screen and suitable settings for that scene will be used.

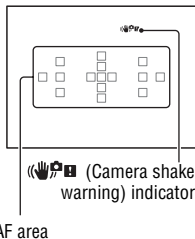

AF area

- 4 When using a zoom lens, turn the zoom ring, then decide on your shot.**

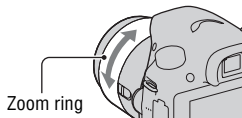

Zoom ring

5 Press the shutter button halfway down to focus.

When the focus is confirmed, ● or (●) (Focus indicator) lights up.

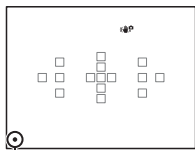
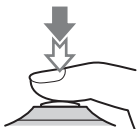

Focus indicator

6 Press the shutter button fully down to shoot.

- When [Auto Object Framing] is set to [Auto] and the camera shoots faces, close-ups, or subjects tracked by [Lock-on AF], the camera automatically trims the image into a suitable composition. Both the original and the trimmed images are saved (page 53).

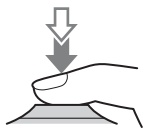

Recording movies

1 Press the MOVIE button to start recording.

- Movie recording can be started from any exposure mode.
- The shutter speed and aperture are adjusted automatically. If you want to set them to particular values, set the mode dial to  (Movie) (page 36).
- The camera continues to adjust the focus when it is in autofocus mode.

MOVIE button

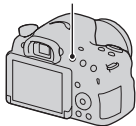

2 Press the MOVIE button again to stop recording.

Notes

- The sound of the camera and the lens in operation may be recorded while recording a movie. You can disable sound recording by setting [Audio Recording] to [Off] (page 57).
- The continuous recording time of a movie may be shorter, depending on the ambient temperature or the status of the camera. See “Notes on continuous movie recording.”
- When the  icon appears, the temperature of the camera is too high. Turn the camera off and wait until the temperature of the camera drops.

Playing back images

1 Press the  button.

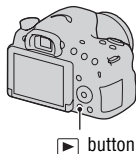

2 MENU button →  1 → [Still/Movie Select] → Select the desired mode

- To play back still images, select [Folder View(Still)], and to play back movies, select [Folder View(MP4)] or [AVCHD View], depending on the file format.

3 Select an image using /  on the control button.

- To play back movies, press the center of the control button.

During movie playback	Control button/control dial operation
To pause/resume	●
To fast-forward	▶
To fast-reverse	◀
To slow-forward	Rotate the control dial to the right during pause.
To slow-reverse	Rotate the control dial to the left during pause. <ul style="list-style-type: none">• The movie is played back frame-by-frame.
To adjust sound volume	▼ → ▲/▼
To display the information	▲

Notes

- Movies recorded using other devices may not play back on this camera in some cases.

Deleting images (Delete)

Once you have deleted an image, the image cannot be restored. Be sure that you do not want the image before deleting it.

- 1 Display the image you want to delete and press the  button.**

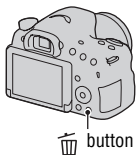

- 2 Select [Delete] using  on the control button, then press the center of the control button.**
-

Notes

- Protected images cannot be deleted.

Adjusting the angle of the LCD screen

Adjust the LCD screen to an easily viewable angle.

- The LCD screen tilts down about 55 degrees and up about 135 degrees.

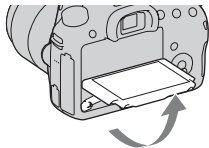
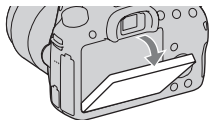

Shooting images to suit your subject

Selecting a shooting mode

Set the mode dial to the desired shooting mode.



The following shooting modes are available:

i (Intelligent Auto) / i+ (Flash Off) (30)	In [Intelligent Auto] mode, the camera analyzes the subject and allows you to shoot with the appropriate settings. Select [Flash Off] when you want to shoot without the flash.
i+ (Superior Auto) (37)	The camera recognizes and evaluates the shooting conditions, and appropriate settings are set automatically. The camera saves 1 appropriate image by combining or extracting images, as necessary.
SCN (Scene Selection) (38)	Allows you to shoot with preset settings according to the scene.
Sweep Panorama (39)	Allows you to shoot panoramic images.
Picture Effect (54)	Allows you to shoot still images with a texture unique to the selected effect.
T (Tele-zoom Cont. Priority AE) (40)	The camera continues to shoot while the shutter button is pressed fully down. The camera records images continuously at a maximum of about 8 images per second.
Movie (32)	Allows you to shoot movies with the exposure (both the shutter speed and the aperture value) adjusted manually.
P (Program Auto)	Allows you to shoot with the exposure (both the shutter speed and the aperture value) adjusted automatically. The other settings can be adjusted manually.
A (Aperture Priority)	Allows you to shoot after adjusting the aperture value manually using the control dial.
S (Shutter Priority)	Allows you to shoot after adjusting the shutter speed manually using the control dial.
M (Manual Exposure)	Allows you to shoot after adjusting the exposure (both the shutter speed and the aperture value) manually using the control dial.

iA+ Superior Auto

1 Set the mode dial to iA+ (Superior Auto).

2 Point the camera towards the subject, and adjust the focus and shoot the subject.

Scene recognition

When the camera recognizes the subject and adjusts itself for shooting conditions, the following information appears on the screen: Scene Recognition icon, appropriate shooting function, and the number of images to be shot.

Recognized scene: 🌙 (Night Scene), 🖐️ (Hand-held Twilight), 🏔️ (Landscape), 📷 (Backlight Portrait), 👤 (Portrait), 🌃 (Tripod Night Scene), 📷 (Backlight), 🌸 (Macro), 🌙 (Night Portrait), 📷 (Spotlight), 📷 (Low Brightness), 🍼 (Baby)

Shooting function: Cont. Shooting, Slow Sync. (page 41), Auto HDR (page 54), Daylight Sync., Slow Shutter, Hand-held Twilight

Scene Recognition icon

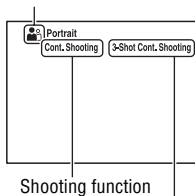

Number of images to be shot









SCN Scene Selection

1 Set the mode dial to **SCN (Scene Selection)**, then press the center of the control button.

2 Select the desired mode using **▲/▼**, then press the center of the control button.

- To change the scene, press the Fn button, then select another scene.

3 Adjust the focus and shoot the subject.

 (Portrait)	Blurs away backgrounds and sharpens the subject. Accentuates skin tones softly.
 (Sports Action)	Shoots a moving subject at a fast shutter speed so that the subject looks as if it is standing still. The camera shoots images continuously while the shutter button is pressed.
 (Macro)	Shoots close-ups of the subjects such as flowers and foods.
 (Landscape)	Shoots the entire range of scenery in sharp focus with vivid colors.
 (Sunset)	Shoots the red of the sunrise or sunset beautifully.
 (Night Scene)	Shoots night scenes at a distance without losing the dark atmosphere of the surroundings.
 (Hand-held Twilight)	Shoots night scenes with less noise and blur without using a tripod. A burst of shots are taken, and image processing is applied to reduce subject blur, camera shake, and noise.
 (Night Portrait)	Shoots portraits in night scenes.

☐ Sweep Panorama

- 1 Set the mode dial to ☐ (Sweep Panorama).
- 2 Point the camera at the subject for which you want to adjust the brightness and focus, and press the shutter button halfway down.
- 3 Point the camera at the edge of the composition while pressing the shutter button halfway down, and then press the shutter button fully down.

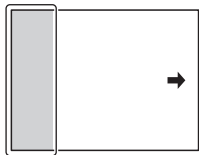

This part will not be shot.

- 4 Pan or tilt the camera to the end, following the guidance on the screen.

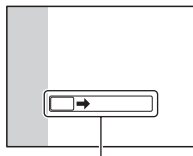

Guidance bar

Shooting images to suit your subject

T [8] Tele-zoom Cont. Priority AE**1** Set the mode dial to **T [8]** (Tele-zoom Cont. Priority AE).**2** Adjust the focus and shoot the subjects.

- The camera continues to shoot while the shutter button is pressed fully down.
- The center area on the screen is cropped and the camera records the images continuously at a maximum of about 8 images per second.
- The minimum zoom scale of the camera is set to 2 times and the image size is set to S.

Shooting techniques

- When [AEL w/ shutter] is set to [Off], the camera continues to adjust the exposure even after the first shot in [Cont. Shooting] or [Tele-zoom Cont. Priority AE] (page 56).
- When [Autofocus Mode] is set to [Continuous AF], the camera continues to adjust focus during shooting. You can set [ISO] to the desired number.

Using the flash

In dark environments, use the flash to shoot the subject brightly and to prevent camera shake. When shooting against the sun, use the flash to lighten the image of the backlit subject.

1 Fn button → ⚡ (Flash Mode) → Select the desired setting

- For further information on the flash modes available for each shooting mode, see page 75.

2 Press the ⚡ button.

The built-in flash pops up.

- In [Intelligent Auto], [Superior Auto], or [Scene Selection] mode, the built-in flash does not pop up even if you press the ⚡ button. In these modes, the flash automatically pops up if the amount of light is insufficient or the subject is backlit.

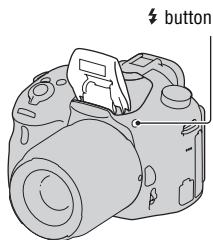

3 After the flash has finished charging, shoot the subject.





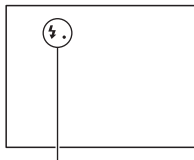

⚡● Blinking: The flash is being charged. While the indicator is blinking, you cannot trigger the shutter.

⚡● Lit: The flash has been charged and is ready to fire.

- When you press the shutter button halfway down under dark lighting in autofocus mode, the flash may be fired to help focus on a subject (AF Illuminator).



⚡● (Flash charging) indicator

 (Flash Off)	Does not fire even if the flash is raised. <ul style="list-style-type: none">• You cannot select this item when the mode dial is set to P, A, S, or M. If you do not want to use the flash in these modes, push the flash down.
 (Autoflash)	Fires in dark environments or when shooting towards bright light.
 (Fill-flash)	Fires every time you trigger the shutter.
 (Slow Sync.)	Fires every time you trigger the shutter. Slow sync shooting allows you to shoot a clear image of both the subject and the background by slowing the shutter speed.
 (Rear Sync.)	Fires right before the exposure is completed every time you trigger the shutter.
 (Wireless)	Fires an external flash (sold separately) that is off the camera and away from it (wireless flash shooting).

Adjusting the image brightness

Normally, the exposure is automatically selected (Automatic exposure). Based on the exposure acquired by the automatic exposure, you can perform exposure compensation. You can make the entire image brighter by shifting to the + side. The entire image becomes darker when you shift to the - side (Exposure compensation).

1 Press the button.

 button



2 Adjust the exposure using the control dial.

Toward + (over): Brightens an image.

Toward - (under): Darkens an image.

- In viewfinder mode, confirm the exposure using the EV scale.

The LCD screen after the exposure is adjusted.

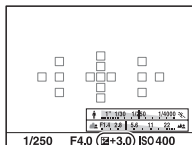

Compensated exposure

The screen in the viewfinder

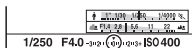

Standard exposure

3 Adjust the focus and shoot the subject.

Shooting techniques

- Adjust the compensation level by checking the recorded image.
- Using bracket shooting, you can shoot multiple images with the exposure shifted to the plus or minus sides (page 45).

Notes



- This item cannot be set when the exposure mode is set to [Intelligent Auto], [Superior Auto], or [Scene Selection].
- When the exposure mode is set to M, the exposure can be adjusted only when [ISO] is set to [AUTO]. Turn the control dial during AE lock to adjust the compensation value.
- Even though you can adjust the exposure between -3.0 EV and $+3.0$ EV, only a value between -2.0 EV and $+2.0$ EV with the equivalent image brightness appears on the screen when shooting. If you set an exposure beyond this range, the image brightness on the screen does not show the effect, but it will be reflected on the recorded image.

/ **Selecting the drive mode**

You can select the appropriate drive mode, such as single, continuous, or bracket shooting, to suit your purpose.

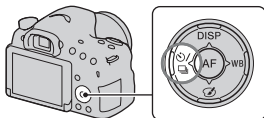
 /  **on the control button** →
Select the desired mode



 (Single Shooting)	This mode is for normal shooting.
 (Cont. Shooting)	The camera records images continuously.
 (Self-timer)	The 10-second self-timer is convenient if the photographer wants to appear in the photo, while the 2-second self-timer is convenient for reducing the camera shake.
BRK C (Bracket: Cont.)	You can shoot 3 images, each with different degrees of exposure.
BRK S (Single Bracket)	You can shoot 3 images, shot by shot, each with different degrees of exposure.
BRK WB (WB bracket)	Based on the selected white balance and the color temperature/color filter, 3 images are recorded with the white balance shifted.

Switching the recording information display (DISP)

Each time you press DISP on the control button, the recording information display changes as follows.

You can set the recording information display separately for viewfinder mode and LCD screen mode.

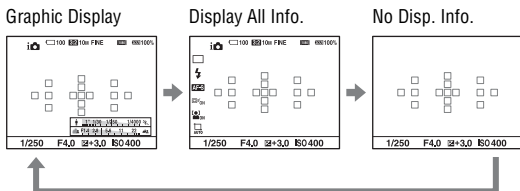
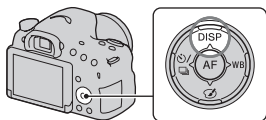

Graphic Display

[Graphic Display] shows the shutter speed and aperture value as graphs, and clearly illustrates how the exposure works. The pointers on the shutter speed indicator and aperture indicator indicate the current value.

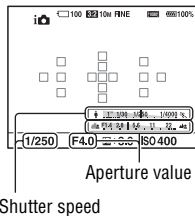

Setting image size

Image Size

MENU button →  **1** → **[Image Size]** → **Select the desired size**

[Aspect Ratio]: [3:2]

Image size		Usage guidelines
L: 20M	5456 × 3632 pixels	For shooting at the highest image quality
M: 10M	3872 × 2576 pixels	For prints up to A3+ size
S: 5.0M	2736 × 1824 pixels	For prints up to A5 size

[Aspect Ratio]: [16:9]

Image size		Usage guidelines
L: 17M	5456 × 3064 pixels	For viewing on a high-definition TV
M: 8.4M	3872 × 2176 pixels	
S: 4.2M	2736 × 1536 pixels	

Notes

- When [Quality] is set to [RAW] or [RAW & JPEG], the image size of the RAW image corresponds to L. This size is not displayed on the screen.

Panorama: Size

You can set the image size for panoramic images. The image size varies depending on the setting of the shooting direction (page 55).

MENU button →  **1** → **[Panorama: Size]** → **Select the desired size**

Standard	[Panorama: Direction] is set to [Up] [Down]: 3872 × 2160 [Panorama: Direction] is set to [Right] [Left]: 8192 × 1856
Wide	[Panorama: Direction] is set to [Up] [Down]: 5536 × 2160 [Panorama: Direction] is set to [Right] [Left]: 12416 × 1856

Enlarging images

A still image can be enlarged for closer examination. This is convenient for checking the focus condition of a recorded image.

1 Display the image you want to enlarge, then press the  button.

 button

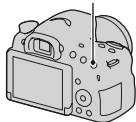

2 Zoom the image in or out using the  button or  button.

- Rotate the control dial to switch images at the same magnification. When you shoot multiple images with the same composition, you can compare their focus conditions.

3 Select the portion you want to enlarge using , , , or  on the control button.

To cancel the enlarged playback

Press the center of the control button and the image returns to normal size.

Switching to the image list display

You can display multiple images on the screen simultaneously.

Press the button.

The image index screen is displayed.

- You can select the number of images displayed on one page of the image index screen using [Image Index] in the

 Playback menu.

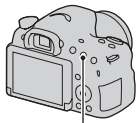



 button

To return to the single-image screen

Press the center of the control button after selecting the desired image.

To display the desired folder

Select the bar on the left of the image index screen using the control button, then select the desired folder using /.

Press the center of the control button while the bar is selected to switch the view mode.



Viewing images on a TV screen

To view images that were recorded on the camera on a TV set, an HDMI cable (sold separately) and an HD TV equipped with an HDMI connector are required.

1 Turn off both your camera and the TV, and connect the camera to the TV.

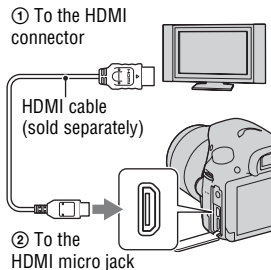



2 Turn on the TV and switch the input.

- See also the operating instructions supplied with the TV.

3 Turn on the camera, and press the button.

Images shot using the camera appear on the TV screen.





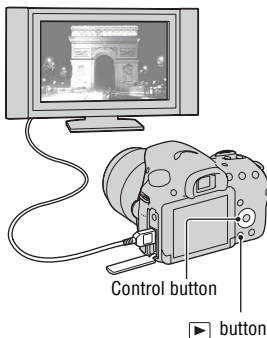



Select the desired image using   on the control button.

- The LCD screen on the camera does not turn on.



Functions that can be operated using the buttons/switch

You can set up or operate various functions using the buttons/switch. For the location of the buttons/switch, see “Identifying parts” (page 13).

 button (41)	Pops the flash up.
 button (43)/AV button/  button (48)	Adjusts the exposure./Sets up the aperture value./Scales an image up when viewing images.
ISO button (53)	Adjusts the ISO sensitivity.
FINDER/LCD button (57)	Switches the display between the LCD screen and the viewfinder.
MENU button (55)	Displays the menu screen for setting up the menu item.
MOVIE button (32)	Records movies.
AEL button/  button (49)/  button (48)	Fixes the exposure of the entire screen./Displays multiple images on the screen simultaneously./Scales down an image that has been scaled up when viewing images.
ZOOM button	Magnifies and shoots the subject using the zoom feature of the camera.
Fn button (52, 53)/  button	Displays the setup screen for a function set using the Fn button./Rotates images.
Control button	Sets up the following functions: Display Contents (46), White Balance (54), Drive Mode (45), Picture Effect (54), and Autofocus.
 button (33)	Plays back images.
? button (62)/  button (34)	Displays a shooting tip or In-Camera Guide./Deletes images.
Focus mode switch	Switches the autofocus and manual focus.
Preview button/Focus Magnifier button	Checks blurring of the background./Allows you to check the focus by enlarging the image before shooting.

Selecting a function using the Fn (Function) button

This button is used for setting up or executing functions used frequently in shooting.

1 Press the Fn button.

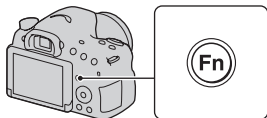

2 Select the desired item using ▲/▼/◀/▶ on the control button, then press the center ● to execute.

The setup screen appears.

3 Following the operation guide, select and execute the desired function.

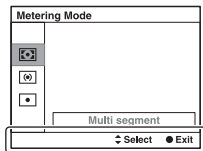

Operation guide

To set up the camera directly from the recording information screen

Turn the control dial without pressing the center ● in step 2. You can set up the camera directly from the recording information screen.

Functions that can be selected using the Fn (Function) button

The functions that can be selected using the Fn button are as follows:

Scene Selection (38)	Selects an appropriate mode from among the Scene Selection preset settings to suit shooting conditions. (Portrait/Sports Action/Macro/Landscape/Sunset/Night Scene/Hand-held Twilight/Night Portrait)
Movie	Selects the exposure mode to suit your subject or your effect and records movies. (P/A/S/M)
Drive Mode (45)	Sets a drive mode, such as continuous shooting. (Single Shooting/Cont. Shooting/Self-timer/Bracket: Cont./Single Bracket/WB bracket)
Flash Mode (41)	Sets the flash mode. (Flash Off/Autoflash/Fill-flash/Slow Sync./Rear Sync./Wireless)
Autofocus Mode	Selects the focus method according to the movement of the subject. (Single-shot AF/Automatic AF/Continuous AF)
AF area	Selects the focus area. (Wide/Zone/Spot/Local)
Lock-on AF	Keeps the focus on a subject while tracking it. (Off/On/On(Lock-on AF w/ shutter))
Smile/Face Detect.	Automatically captures people's face(s) with the optimal focus and exposure./Shoots when a smile is detected. (Face Detection Off/Face Detection On (Regist. Faces)/Face Detection On/Smile Shutter)
Auto Object Framing	When shooting faces, close-ups, or subjects tracked by [Lock-on AF], the camera analyzes the scene and automatically trims the image into a suitable composition. (Off/Auto)
ISO	Sets the sensitivity to light. The larger the number, the faster the shutter speed. (Multi Frame Noise Reduct./ISO AUTO, ISO 100 to 16000)
Metering Mode	Selects the method for measuring brightness. (Multi segment/Center weighted/Spot)
Flash Comp.	Adjusts the intensity of the flash output. (-2.0EV to +2.0EV)

White Balance	Adjusts the color tone of images. (Auto WB/Daylight/Shade/Cloudy/Incandescent/Fluor.: Warm White/Fluor.: Cool White/Fluor.: Day White/Fluor.: Daylight/Flash/C.Temp./Filter/Custom)
DRO/Auto HDR	Adjusts the brightness and contrast automatically. (Off/D-Range Opt./Auto HDR)
Creative Style	Selects the desired image processing. (Standard/Vivid/Portrait/Landscape/Sunset/Black & White)
Picture Effect	Shoots with the desired effect filter to achieve more impressive images. (Off/Toy Camera/Pop Color/Posterization/Retro Photo/Soft High-key/Partial Color/High Contrast Mono./Soft Focus/ HDR Painting/Rich-tone Mono./Miniature)

Functions selected using the MENU button

You can set the basic settings for the camera as a whole or execute functions such as shooting, playback, or other operations.

Press the MENU button, then set up the desired item using ▲/▼/◀/▶ on the control button, then press the center of the control button.

Select a menu page

Select a menu item

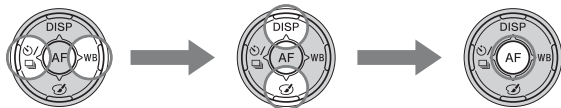

Still shooting menu



Image Size (47)	Selects the size of still images. (L: 20M/M: 10M/S: 5.0M (When [Aspect Ratio] is set to [3:2]) L: 17M/M: 8.4M/S: 4.2M (When [Aspect Ratio] is set to [16:9]))
Aspect Ratio	Selects the aspect ratio for still images. (3:2/16:9)
Quality	Sets the image quality for still images. (RAW/RAW & JPEG/Fine/Standard)
Panorama: Size (47)	Selects the size of panoramic images. (Standard/Wide)
Panorama: Direction	Sets the shooting direction for panoramic images. (Right/Left/Up/Down)



Clear Image Zoom	Zooms an image with higher quality than Digital Zoom. (On/Off)
Digital Zoom	Zooms an image with higher magnification than Clear Image Zoom. This feature is also available for movie recording. (On/Off)

Long Exposure NR	Sets noise reduction processing for shots with a shutter speed of 1 second or longer. (On/Off)
High ISO NR	Sets noise reduction processing for high-sensitivity shooting. (High/Normal/Low)
Flash control	Sets the method for determining the intensity of flash output. (ADI flash/Pre-flash TTL)
AF Illuminator	Sets the AF illuminator, which provides light for a dark scene to aid focusing. (Auto/Off)



SteadyShot	Sets SteadyShot. (On/Off)
Color Space	Changes the range of reproducible colors. (sRGB/AdobeRGB)
AEL w/ shutter	Sets whether to fix the exposure by pressing the shutter button halfway down. This is convenient when you want to adjust the focus and exposure separately. (On/Off)
Shooting Tip List (62)	Allows you to access all shooting tips.

Movie shooting menu



File Format	Selects the movie file format. (AVCHD/MP4)
Record Setting	Selects the size of the recorded movie frame. (60i 24M(FX)/50i 24M(FX)/60i 17M(FH)/50i 17M(FH)/24p 24M(FX)/25p 24M(FX)/24p 17M(FH)/25p 17M(FH)/1440×1080 12M/VGA 3M)
SteadyShot	Sets SteadyShot. (On/Off)
AF Track. Duration	Sets the tracking sensitivity of the autofocus feature for movie recording. (High/Mid/Low)

Audio Recording	Sets whether to record audio when shooting a movie. (On/Off)
Wind Noise Reduct.	Reduces wind noise during movie recording. (On/Off)

Custom menu

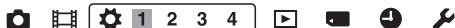

Eye-Start AF	Sets whether to use auto focus when you look through the viewfinder. (On/Off)
FINDER/LCD Setting	Sets the method for switching between the viewfinder and LCD screen. (Auto/Manual)
Red Eye Reduction	Reduces the red-eye phenomenon during flash use. (On/Off)
Release w/o Lens	Sets whether the shutter can open when a lens is not attached. (Enable/Disable)
S. Auto Cont. Shooting	Sets whether to shoot continuously in [Superior Auto] mode. (Auto/Off)
S. Auto Image Extract.	Sets whether to save all the images that were shot continuously in [Superior Auto] mode. (Auto/Off)

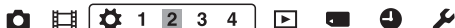

Grid Line	Sets a grid line display to enable alignment to a structural outline. (Rule of 3rds Grid/Square Grid/Diag. + Square Grid/Off)
Auto Review	Displays the captured image after shooting. Sets auto review. (10 Sec/5 Sec/2 Sec/Off)
DISP Button(Monitor)	Sets the LCD screen display modes that can be selected by pressing DISP on the control button. (Graphic Display/Display All Info./No Disp. Info./Histogram/For viewfinder)
DISP Button(Finder)	Sets the viewfinder screen display modes that can be selected by pressing DISP on the control button. (Graphic Display/Display All Info./No Disp. Info./Histogram)

Peaking Level	Enhances the outline of in-focus ranges with a specific color in manual focus mode. (High/Mid/Low/Off)
Peaking Color	Sets the color used for the peaking function. (Red/Yellow/White)
Live View Display	Sets whether to display the effect of a function on the screen, such as the effect of the exposure compensation value. (Setting Effect ON/Setting Effect OFF)

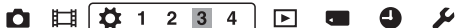

Func. of AEL button	Assigns the desired function to the AEL button. (Exposure Comp./Drive Mode/Flash Mode/Autofocus Mode/AF area/Smile/Face Detect./Auto Object Framing/ISO/Metering Mode/Flash Comp./White Balance/DRO/Auto HDR/Creative Style/Picture Effect/Image Size/Quality/AEL hold/AEL toggle/ AEL hold/ AEL toggle/Lock-on AF/AF lock/Aperture Preview/Shot. Result Preview/Zoom/Focus Magnifier)
ISO Button	Assigns the desired function to the ISO button. (Exposure Comp./Drive Mode/Flash Mode/Autofocus Mode/AF area/Smile/Face Detect./Auto Object Framing/ISO/Metering Mode/Flash Comp./White Balance/DRO/Auto HDR/Creative Style/Picture Effect/Image Size/Quality/AEL hold/AEL toggle/ AEL hold/ AEL toggle/Lock-on AF/AF lock/Aperture Preview/Shot. Result Preview/Zoom/Focus Magnifier)
Preview Button	Selects the function to be assigned to the preview button. (Shot. Result Preview/Aperture Preview/Focus Magnifier)
Focus Hold Button	Sets the function of the focus hold button of the lens. (Focus Hold/D.O.F.Preview)
MOVIE Button	Sets whether to always activate the MOVIE button. (Always/Movie Mode Only)



Lens Comp.: Shading	Compensates for shaded corners on the screen caused by the attached lens. (Auto/Off)
Lens Comp.: Chro. Aber.	Reduces the color deviation at the corners of the screen caused by the attached lens. (Auto/Off)

Lens Comp.: Distortion	Compensates for distortion on the screen caused by the attached lens. (Auto/Off)
e-Front Curtain Shutter	Sets whether or not to use the electronic front curtain shutter function. (On/Off)
Face Registration	Registers or changes the person to be given priority when focusing. (New Registration/Order Exchanging/Delete/Delete All)

Playback menu



Still/Movie Select	Allows you to determine how to group the playback images. (Folder View(Still)/Folder View(MP4)/AVCHD View)
Delete (34)*	Deletes images. (Multiple Img./All in Folder/All AVCHD view files)
Slide Show	Plays a slide show. (Repeat/Interval/Image Type)
Image Index (49)	Displays the image list. (4 Images/9 Images)
Protect*	Protects images, or cancels the protection. (Multiple Img./Cancel All Images/Cancel All Movies(MP4)/Cancel All AVCHD view files)
Specify Printing	Specifies or unspecifies the images for DPOF. (DPOF Setup/Date Imprint)

* Available items differ depending on the view mode.

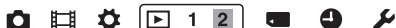

Volume Settings	Sets the volume for movie playback.
Playback Display	Sets how to play back an image recorded in portrait. (Auto Rotate/Manual Rotate)

Memory Card Tool menu



Format	Formats the memory card.
File Number	Sets the method used to assign file numbers to still images and MP4 movies. (Series/Reset)
Folder Name	Sets the folder format for still images. (Standard Form/Date Form)
Select REC Folder	Changes the selected folder for storing still images and MP4 movies.
New Folder	Creates a new folder for storing still images and MP4 movies.
Recover Image DB	Recovers the image database file and enables recording and playback.
Display Card Space	Displays the remaining recording time of movies and the recordable number of still images on the memory card.

Clock setup menu



Date/Time Setup (27)	Sets date and time and daylight savings.
Area Setting (28)	Selects the area where you are using the camera.

Setup menu



Menu start	Selects a first-displayed menu from the top menu or the last menu screen. (Top/Previous)
Mode Dial Guide	Turns on or off the mode dial guide (the explanation of each shooting mode). (On/Off)
LCD Brightness	Sets the brightness of the LCD screen.
Viewfinder Bright.	Sets the brightness of the viewfinder. (Auto/Manual)
Viewfinder Color Temp.	Sets the color temperature of the screen in the viewfinder. Setting it toward + makes the color cooler, and toward - makes the color warmer. (+2 to 0 to -2)

Power Save	Sets the level of the power saving feature. (Max/Standard)
Power Saving Start Time	Sets the interval after which power save mode engages. (30 Min/5 Min/1 Min/20 Sec/10 Sec)



HDMI Resolution	Sets the resolution when the camera is connected to an HDMI TV. (Auto/1080p/1080i)
CTRL FOR HDMI	Operates the camera from a TV that supports “BRAVIA” Sync. (On/Off)
Upload Settings*	Sets whether to use the upload function of the camera with an Eye-Fi card. (On/Off)
USB Connection	Selects the appropriate USB connection method for each computer or USB device connected to the camera. (Auto/Mass Storage/MTP/PC Remote)
USB LUN Setting	Enhances compatibility by limiting the functions of USB connection. Normally, use [Multi], and if you cannot make a connection, set it to [Single]. (Multi/Single)
Audio signals	Sets whether to use the beep sound when the focus is achieved or the self-timer is working. (On/Off)

* Appears when an Eye-Fi card (sold separately) is inserted in the camera.



Version	Displays the camera software version.
Language	Selects the language.
Cleaning Mode	Starts cleaning mode to clean the image sensor.
Demo Mode	Sets the demonstration playback of a movie to on or off. (On/Off)
Initialize	Restores the settings to their defaults. (Reset Default/Rec mode reset/Custom reset)

Using the guide function of the camera

In-Camera Guide

When you press the ? (In-Camera Guide) button on the Fn (Function) screen or menu screen, a guide for the currently selected function or setting automatically appears.

To select unavailable functions or settings on the Fn screen, press the center of the control button to display the appropriate setup to enable them.

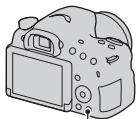

? (In-Camera Guide) button

Shooting Tips

The camera displays shooting tips in accordance with the shooting mode selected.

1 Press the ? (In-Camera Guide) button when the recording information display is displayed.

A shooting tip list for the current subject automatically appears.

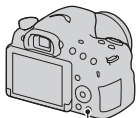

? (In-Camera Guide) button

2 Select the desired shooting tip using ▲/▼ on the control button, then press the center of the control button.

The shooting tip is displayed.

- You can scroll the screen using ▲/▼.
- You can select the item using ◀/▶.

To access all shooting tips

You can search through all the shooting tips from the menu.

Use this item when you want to read shooting tips you have seen before.

MENU button →  **3** → **[Shooting Tip List]** → **Select the desired shooting tip**

What you can do with software

To utilize images recorded with the camera, use the following software:

- “PlayMemories Home” (Windows only)

You can import still images or movies recorded with the camera to your computer so that you can view them, and use various convenient features to enhance the images you have shot. “PlayMemories Home” is required when importing AVCHD movies to your computer.

- “Image Data Converter”

You can retouch RAW format images and convert them into JPEG/TIFF format.

What you can do with “PlayMemories Home”

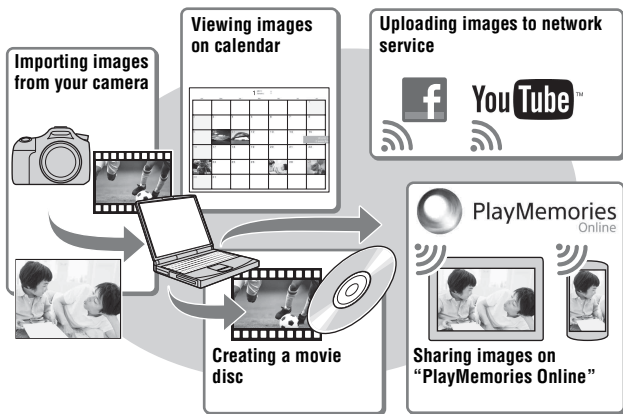

Installing “PlayMemories Home” (for Windows only)

You can install “PlayMemories Home” from the following URL (page 66):
www.sony.net/pm

Notes

- An Internet connection is required to install “PlayMemories Home.”
- An Internet connection is required to use “PlayMemories Online” or other network services. “PlayMemories Online” or other network services may not be available in some countries or regions.
- “PlayMemories Home” is not compatible with Macs. Use the applications that are installed on your Mac. For details, visit the following URL:
<http://www.sony.co.jp/imsoft/Mac/>

What you can do with “Image Data Converter”

With “Image Data Converter,” you can do the following:

- You can play back and edit images recorded in RAW format with various corrections, such as tone curve and sharpness.
- You can adjust images with white balance, exposure, and [Creative Style], etc.
- You can save the images displayed and edited on a computer. You can either save the image as RAW format or save it in the general file format (JPEG/TIFF).
- You can display and compare the RAW images and JPEG images recorded by this camera.
- You can rank images in 5 grades.
- You can apply color labels, etc.

Installing “Image Data Converter” (Windows/Mac)

You can download “Image Data Converter” from the following URL (page 67):

<http://www.sony.co.jp/ids-se/>

Notes

- An Internet connection is required to install “Image Data Converter.”

Installing the software

Installing “PlayMemories Home”

- Log on as Administrator.
- If the software “PMB (Picture Motion Browser),” supplied with models released before 2011, has already been installed on your computer, “PlayMemories Home” will overwrite it and will be installed. Although some “PlayMemories Home” functions differ from those of “PMB,” use “PlayMemories Home.”

1 Using the Internet browser on your computer, go to the following URL, then click [Install] → [Run].

www.sony.net/pm

2 Follow the instructions on the screen to complete the installation.

- When the message to connect the camera to a computer is displayed, connect the camera and computer using the micro USB cable (supplied).

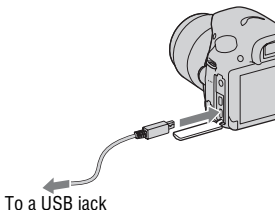

Viewing “PlayMemories Home Help Guide”

For details on how to use “PlayMemories Home,” refer to the “PlayMemories Home Help Guide.”

Double-click the [PlayMemories Home Help Guide] icon on the desktop.

- To access the “PlayMemories Home Help Guide” from the start menu: Click [Start] → [All Programs] → [PlayMemories Home] → [PlayMemories Home Help Guide].

- For Windows 8, select the [PlayMemories Home] icon on the Start screen, then launch “PlayMemories Home” and select [PlayMemories Home Help Guide] from the [Help] menu.
- For details on “PlayMemories Home,” you can also see the following PlayMemories Home support page (English only):
<http://www.sony.co.jp/pmh-se/>

Installing “Image Data Converter”

1 Using the Internet browser on your computer, go to the following URL.

For Windows: <http://www.sony.co.jp/imsoft/Win/>

For Mac: <http://www.sony.co.jp/imsoft/Mac/>

2 Follow the instructions on the screen to complete the installation.

Viewing “Image Data Converter Guide”

For details on how to use “Image Data Converter,” refer to the “Image Data Converter Guide.”

For Windows:

Click [Start] → [All Programs] → [Image Data Converter] → [Help] → [Image Data Converter Ver.4].

For Mac:

Start Finder → [Applications] → [Image Data Converter] → [Image Data Converter Ver.4] → In the menu bar, choose “Help” → “Image Data Converter Guide.”

- For Windows 8, start “Image Data Converter Ver.4” → In the menu bar, choose “Help” → “Image Data Converter Guide.”
- For details on “Image Data Converter,” you can also see the following “Image Data Converter” support page (English only):
<http://www.sony.co.jp/ids-se/>

Installing “Remote Camera Control”

To use “Remote Camera Control,” connect the camera to a computer. The following functions are available.

- You can set up the camera or shoot an image from the computer.
 - You can record an image directly to the computer.
 - You can perform Interval Timer Shooting.
-

1 Using the Internet browser on your computer, go to the following URL.

For Windows: <http://www.sony.co.jp/imsoft/Win/>

For Mac: <http://www.sony.co.jp/imsoft/Mac/>



2 Follow the instructions on the screen to complete the installation.

- For details on how to use “Remote Camera Control,” refer to the “Help.”

Selecting the method for creating a movie disc

Depending on the disc type, playable devices may vary. Select the method that suits your disc player.

There are two ways to create a movie disc. Use “PlayMemories Home” on your computer or create a disc using devices other than a computer, such as a recorder.

Disc type/usage	Record setting available		Player
	FX	FH	
 To keep high-definition image quality (HD)	✓	✓	Blu-ray disc playback devices (Sony Blu-ray disc player, PlayStation®3, etc.)
 To keep high-definition image quality (HD) (AVCHD recording disc)	—*	✓	AVCHD format playback devices (Sony Blu-ray disc player, PlayStation®3, etc.)
 To keep standard definition image quality (STD)	—*	—*	Ordinary DVD playback devices (DVD player, computer that can play DVDs, etc.)

* Movies recorded with the [60i 24M(FX)]/[50i 24M(FX)] or [24p 24M(FX)]/[25p 24M(FX)] setting in [Record Setting] are converted by “PlayMemories Home” in order to create an AVCHD recording disc. This conversion can take a long time. Also, you cannot create a disc with the original image quality. If you want to keep the original image quality, store your movies on a Blu-ray disc.

Creating a disc using a computer

You can import AVCHD movies to a computer using “PlayMemories Home,” and create an AVCHD recording disc or a standard definition quality (STD) disc.

For details on how to create a disc using “PlayMemories Home,” see “PlayMemories Home Help Guide.”





Notes

- To create Blu-ray discs using “PlayMemories Home,” install our proprietary add-on software. For details, access the following URL:
<http://support.d-imaging.sony.co.jp/BDUW/>
- PlayStation®3 may not be available in some countries/regions.
- Movies recorded with the [60i 24M(FX)]/[50i 24M(FX)] or [24p 24M(FX)]/[25p 24M(FX)] setting in [Record Setting] are converted by “PlayMemories Home” in order to create an AVCHD recording disc. This conversion can take a long time. Also, you cannot create a disc with the original image quality. If you want to keep the original image quality, store your movies on a Blu-ray disc.

Creating a disc with a device other than a computer

You can create a disc using a Blu-ray disc recorder, etc.

The disc type you can create depends on the device used.

Device	Disc type	
 <p>Blu-ray disc recorder: To create a Blu-ray disc or DVD with standard image quality (STD)</p>	 <p>High-definition image quality (HD)</p>	 <p>Standard definition image quality (STD)</p>
 <p>HDD recorder, etc.: To create a DVD with standard image quality (STD)</p>	 <p>Standard definition image quality (STD)</p>	

Notes

- For details on how to create a disc, refer to the operating instructions of the device you use.

List of screen icons

Graphic Display (LCD screen)

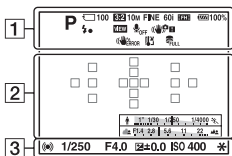

Display All Info. (LCD screen)

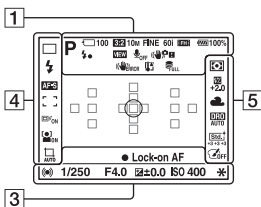

For playback (Basic information display)

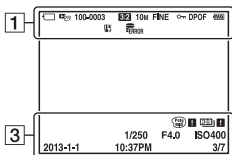

1

Display	Indication
	Exposure mode (36)
	Scene Recognition icons (37)
	Memory card (21)/ Upload (61)
100	Remaining number of recordable images
3:2 16:9	Aspect ratio of still images (55)
20M 10M 5.0M 17M 8.4M 4.2M 	Image size of still images (47)
RAW RAW+J FINE STD	Image quality of still images (55)
60i 24p 50i 25p	Frame rate of movies (56)
	Image size of movies (56)
100%	Remaining battery (23)

Others

Display	Indication
	Flash charge in progress (41)
	Setting Effect OFF (58)
	No audio recording of movies (57)
	SteadyShot/Camera shake warning
	SteadyShot error
	Overheating warning (10)
	Database file full/ Database file error
	View Mode (59)
100-0003	Folder - file number
	Protect (59)
DPOF	DPOF set (59)
	Remaining battery warning (23)

2

Display	Indication
	Spot metering area (53)
	AF area (53)
	Smart Zoom
	Clear Image Zoom (55)
	Digital Zoom (55)
	Zoom magnification
	Shutter speed indicator (46)
	Aperture indicator (46)

3

Display	Indication
REC 0:12	Recording time of the movie (m:s)
	Focus (31)
1/250	Shutter speed
F4.0	Aperture
	EV scale (43) (Only for viewfinder)
	Exposure compensation (43)
	AE lock
	Auto HDR image warning
	Picture Effect error
ISO400	ISO sensitivity (53)
3/7	File number/Number of images in the view mode
2013-1-1 10:37AM	Date of recording

4















Display	Indication
	Drive mode (45)
	Flash mode (41)/Red-eye reduction (57)
	Focus mode
	AF area (53)
	Lock-on AF (53)

Functions available for each shooting mode

The functions you can use depend on the selected shooting mode.

In the table below, ✓ indicates the function is available, and a – indicates the function is not available.

The functions you cannot use are displayed in gray on the screen.

Shoot Mode	Exposure Comp. (43)	Self-timer (45)	Cont. Shooting (45)	Face Detection (53)	Smile Shutter (53)	Auto Object Framing (53)
 (30)	–	✓	✓	✓	✓	✓
 (30)	–	✓	✓	✓	✓	✓
 (37)	–	✓	✓	✓	✓	✓
SCN (38)		–	✓	–	✓	✓
		–	✓	✓	✓	–
		–	✓	–	✓	✓
		–	✓	–	✓	✓
		–	✓	–	✓	✓
		–	✓	–	✓	✓
		–	–	–	✓	–
		–	✓	–	✓	✓
 (39)	✓	–	–	–	–	–
 (40)	✓	–	–	–	–	–
P (36)	✓	✓	✓	✓	✓	✓
A (36)	✓	✓	✓	✓	✓	✓
S (36)	✓	✓	✓	✓	✓	✓
M (36)	✓*	✓	✓	✓	✓	✓
 (32)	✓*	✓	✓	✓	–	–





















* When the exposure mode is set to M, the exposure can be adjusted only when [ISO] is set to [AUTO].

Flash modes available

The flash modes you can select depend on the shooting mode and functions selected.

In the table below, ✓ indicates the function is selectable, and a – indicates the function is not selectable.

The flash modes you cannot select are displayed in gray on the screen.

Shoot Mode	 (Flash Off)	 (Autoflash)	 (Fill-flash)	 (Slow Sync.)	 (Rear Sync.)	 (Wireless)
 (30)	✓	✓	✓	–	–	–
 (30)	✓	–	–	–	–	–
 (37)	✓	✓	✓	–	–	–
SCN (38)		✓	✓	✓	–	–
		✓	–	✓	–	–
		✓	✓	✓	–	–
		✓	–	✓	–	–
		✓	–	✓	–	–
		✓	–	–	–	–
		✓	–	–	–	–
		–	✓	–	✓	–
 (39)	✓	–	–	–	–	–
 (40)	–	–	✓	✓	✓	✓
P (36)	–	–	✓	✓	✓	✓
A (36)	–	–	✓	✓	✓	✓
S (36)	–	–	✓	✓	✓	✓
M (36)	–	–	✓	✓	✓	✓
 (32)	✓	–	–	–	–	–

Others

Learning more about the camera (α Handbook)

The “ α Handbook” can be downloaded from the Internet. Refer to the “ α Handbook” for in-depth instructions on the many camera functions.

1 Access the Sony support page.

<http://www.sony.net/SonyInfo/Support/>

2 Select your country or region.

3 Search for the model name of your camera within the support page.

- Check the model name on the bottom of your camera.
-

Checking the number of recordable images/recording time

Once you insert a memory card into the camera and set the power switch to ON, the number of images that can be recorded (if you continue to shoot using the current settings) is displayed on the screen.

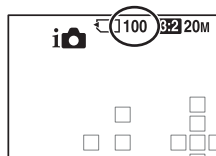

Notes

- When “0” (the number of recordable images) flashes in yellow, the memory card is full. Replace the memory card with another one, or delete images from the current memory card (page 34).
- When “NO CARD” (the number of recordable images) flashes in yellow, it means no memory card has been inserted. Insert a memory card.

The number of images that can be recorded on a memory card

The table shows the approximate number of images that can be recorded on a memory card formatted on this camera. The values are defined using Sony standard memory cards for testing. The values may vary depending on the shooting conditions and the type of memory card used.

Image Size: L: 20M

Aspect Ratio: 3:2*

Memory card formatted on this camera

(Units: Images)

Capacity \ Size	2 GB	4 GB	8 GB	16 GB	32 GB	64 GB
Standard	385	780	1550	3150	6300	12500
Fine	240	485	980	1950	3900	7800
RAW & JPEG	65	125	260	520	1050	2100
RAW	89	175	355	720	1400	2850

* When [Aspect Ratio] is set to [16:9], you can record more images than shown in the table above (except when [RAW] is selected).

Recordable time and number of recordable images possible on a single charged battery pack

Note that the actual number may be less than that indicated depending on the conditions of use.

		Recordable time	Number of images
Shooting (Still images)	LCD screen mode	Approx. 350 min.	Approx. 700 images
	Viewfinder mode	Approx. 345 min.	Approx. 690 images
Movie recording	LCD screen mode	Approx. 160 min.	–
	Viewfinder mode	Approx. 160 min.	–
Continuous movie recording	LCD screen mode	Approx. 265 min.	–
	Viewfinder mode	Approx. 270 min.	–

- The number is calculated when using a battery pack at full capacity and under the following conditions:
 - At an ambient temperature of 25°C (77°F).
 - Using a battery pack that is charged for an hour after the CHARGE lamp goes out.
 - Using Sony “Memory Stick PRO Duo” media (sold separately).
- The number of still images is based on the CIPA standard under the following conditions. (CIPA: Camera & Imaging Products Association)
 - [Quality] is set to [Fine].
 - [Autofocus Mode] is set to [Automatic AF].
 - Shooting once every 30 seconds.
 - Strobing the flash once every 2 times.
 - Turning the power on and off once every 10 times.
- The movie recordable time is based on the CIPA standard under the following conditions.
 - Movie quality: AVCHD FH
 - Movie recording: Repeating operations such as recording, zoom, shooting standby, and the power turns on and off.

- Continuous movie recording: When the limit of the continuous movie recording (29 minutes) is reached, press the MOVIE button and continue recording. No other operations such as zoom are performed.

Available recording time for a movie

The table below shows the approximate total recording times using a memory card formatted on this camera.

Memory card formatted on this camera (h (hour), m (minute))

Record Setting \ Capacity	2 GB	4 GB	8 GB	16 GB	32 GB	64 GB
60i 24M(FX)/50i 24M(FX)	10 m	20 m	45 m	1 h 30 m	3 h	6 h
60i 17M(FH)/50i 17M(FH)	15 m	30 m	1 h	2 h	4 h 5 m	8 h 15 m
24p 24M(FX)/25p 24M(FX)	10 m	20 m	45 m	1 h 30 m	3 h	6 h
24p 17M(FH)/25p 17M(FH)	15 m	30 m	1 h	2 h	4 h 5 m	8 h 15 m
1440×1080 12M	20 m	40 m	1 h 20 m	2 h 45 m	5 h 30 m	11 h 5 m
VGA 3M	1 h 10 m	2 h 25 m	5 h	10 h	20 h 5 m	40 h 15 m

Notes

- The recordable time for movies varies because the camera is equipped with VBR (Variable Bit Rate), which automatically adjusts image quality depending on the shooting scene. When you record fast-moving subjects, the image is clearer but the recordable time is shorter, because more memory is required. The recordable time also varies depending on the shooting conditions or subject or the image quality/size settings.
- The values shown are not for continuous recording time.
- Recording time may depend on shooting conditions and the memory card used.
- When [] is displayed, stop recording. The temperature inside the camera has increased to an unacceptable level.
- For details on movie playback, see page 33.

Notes on continuous movie recording

- It requires a great deal of power to perform high quality movie recording or continuous shooting using the APS-C size image sensor. Therefore, if you continue to shoot, the temperature inside the camera will rise, especially that of the image sensor. In such cases, the camera is turned off automatically, since higher temperatures affect the quality of the images or burden the internal mechanism of the camera.
- The duration of time available for movie recording is as follows when the camera starts recording after the power of the camera has been turned off for a while. (The following values indicate the continuous time from when the camera starts recording until the camera stops recording.)

Ambient temperature	Continuous recording time for movies
20°C (68°F)	About 29 minutes
30°C (86°F)	About 29 minutes
40°C (104°F)	About 29 minutes

- The duration of time available for movie recording varies with the temperature or condition of the camera before you start recording. If you frequently recompose or shoot images after the power is turned on, the temperature inside the camera rises and the recording time available is shorter than the values shown in the table above.
- If the camera stops recording due to the temperature, leave it for several minutes with the power turned off. Start recording after the temperature inside the camera drops fully.
- If you observe the following points, the recording time will be longer.
 - Keep the camera out of direct sunlight.
 - Turn the camera off when it is not being used.
 - If possible, use a tripod and disable the SteadyShot function.
- The maximum size of a movie file is about 2 GB. When the file size is about 2 GB, recording stops automatically when [File Format] is set to [MP4], and a new movie file is created automatically when [File Format] is set to [AVCHD].
- Continuous shooting is possible for approximately 29 minutes (limited by product specifications).
- For [1440×1080 12M] size movies, continuous shooting is possible for approximately 20 minutes (limited by 2 GB file size).

Specifications

Camera

[System]

Camera Type	Interchangeable Lens Digital Camera
Lens	A-mount lens

[Image sensor]

Image format	23.2 mm×15.4 mm (APS-C format), CMOS image sensor
Total pixel number of image sensor	Approx. 20 400 000 pixels
Effective pixel number of camera	Approx. 20 100 000 pixels

[SteadyShot]

For still images	System: Image sensor-shift mechanism Effect: Approx. 2.5 EV to 4.5 EV in shutter speed (depending on shooting conditions and the attached lens)
For movies	System: Electronic

[Anti-Dust]

System	Charge protection coating on Image Sensor and image sensor-shift mechanism
--------	--

[Auto focus system]

System	TTL phase-detection system, 15 points (3 points cross type)
Sensitivity Range	-1 EV to 18 EV (at ISO 100 equivalent)
AF illuminator	Approx. 1 m to 5 m (3.3 ft. to 16.4 ft.)

[Electronic viewfinder]

Type	Electronic viewfinder
Screen size	1.0 cm (0.39 type)
Total number of dots	1 440 000 dots
Frame coverage	100%
Eye Point	Approximately 26.5 mm from the eyepiece, 23 mm from the eyepiece frame (at -1 m ⁻¹)



Diopter Adjustment	-4.0 m ⁻¹ to +4.0 m ⁻¹ (diopter)
[LCD screen]	
LCD panel	6.7 cm (2.7 type) TFT drive/Clear Photo LCD screen
Total number of dots	460 800 dots
[Exposure control]	
Metering Cell	“Exmor” CMOS sensor
Metering method	1 200-zone evaluative metering
Metering Range	-2 EV to +17 EV (at ISO 100 equivalent with F1.4 lens)
ISO sensitivity (Recommended exposure index)	Still images: AUTO (ISO 100 – 3 200), ISO 100 to 16 000 (1 EV step) Movies: AUTO (ISO 100 – 3 200 equivalent), ISO 100 to 3 200 equivalent (1 EV step)
Exposure compensation	±3.0 EV (1/3 EV step)
[Shutter]	
Type	Electronically-controlled, vertical-traverse, focal-plane type
Speed range	Still images: 1/4 000 second to 30 seconds, BULB Movies: 1/4 000 second to 1/4 second (1/3 step), up to 1/60 second in AUTO mode
Flash sync speed	1/160 second
[Built-In-Flash]	
Flash G.No.	GN 10 (in meters at ISO 100)
Recycling time	Approx. 4 seconds
Flash coverage	Covering 18 mm lens (focal length that the lens indicates)
Flash compensation	±2.0 EV (1/3 EV step)

Flash range

Aperture		F2.8	F4.0	F5.6
ISO setting	100	1 m – 3.6 m (3.3 feet – 11.8 feet)	1 m – 2.5 m (3.3 feet – 8.2 feet)	1 m – 1.8 m (3.3 feet – 5.9 feet)
	200	1 m – 5 m (3.3 feet – 16.4 feet)	1 m – 3.6 m (3.3 feet – 11.8 feet)	1 m – 2.5 m (3.3 feet – 8.2 feet)
	400	1.4 m – 7.1 m (4.6 feet – 23.3 feet)	1 m – 5 m (3.3 feet – 16.4 feet)	1 m – 3.6 m (3.3 feet – 11.8 feet)
	800	2 m – 10 m (6.6 feet – 32.8 feet)	1.4 m – 7.1 m (4.6 feet – 23.3 feet)	1 m – 5 m (3.3 feet – 16.4 feet)

[Continuous shooting]

Continuous shooting speed

[Tele-zoom Cont. Priority AE]: Maximum 8 images per second/ Hi: Maximum 5 images per second/ Lo: Maximum 2.5 images per second

- Our measurement conditions. The speed of continuous shooting may be slower, depending on shooting conditions (Image size, ISO setting, High ISO NR, or the setting of [Lens Comp.: Distortion]).

The maximum number of continuous shots

In [Tele-zoom Cont. Priority AE] mode

Fine: 16 images/Standard: 19 images

In Continuous shooting

Fine: 7 images/Standard: 8 images/RAW & JPEG:

5 images/RAW: 6 images

[Image zooming playback]

Scaling range

Image size: L: Approx. $\times 1.0 - \times 15.4$ /M: Approx. $\times 1.0 - \times 11.2$ /S: Approx. $\times 1.0 - \times 7.7$

[Recording format]

File format

JPEG-compliant (DCF Ver. 2.0, Exif Ver. 2.3, MPF Baseline), RAW (Sony's exclusive ARW2.3 format)

Movie (AVCHD format) AVCHD format Ver. 2.0 compatible
 Video: MPEG-4 AVC/H.264
 Audio: Dolby Digital 2ch, equipped with Dolby Digital Stereo Creator

- Manufactured under license from Dolby Laboratories.

Movie (MP4 format) Video: MPEG-4 AVC/H.264
 Audio: MPEG-4 AAC-LC 2ch

[Recording media]

“Memory Stick XC Duo” media, “Memory Stick PRO Duo” media, SD card

[Input/output terminals]

Multi/Micro USB Terminal* USB communication
 * Supports Micro USB compatible device.

HDMI HDMI type D micro jack

Mic Terminal ∅ 3.5 mm Stereo minijack

[Power, general]

Battery pack Rechargeable battery pack NP-FM500H

Power consumption (during shooting)
 When using the viewfinder: Approx. 1.7 W
 When using the LCD screen: Approx. 1.7 W
 (With the SAL18552 lens attached, for shooting still images)

[Others]

Microphone Stereo

Speaker Monaural

Print features Exif Print compatible, PRINT Image Matching III compatible, DPOF compatible

Dimensions (Approx.) 128.6 mm × 95.5 mm × 77.7 mm
 (5 1/8 inches × 3 7/8 inches × 3 1/8 inches) (W/H/D, excluding protrusions)

Mass (Approx.) 573 g (1 lb 4.2 oz) (with battery and “Memory Stick PRO Duo” media)
 492 g (1 lb 1.4 oz) (body only)

Operating temperature 0°C to 40°C (32°F to 104°F)

On image data compatibility

- This camera conforms with the DCF (Design rule for Camera File system) universal standard established by JEITA (Japan Electronics and Information Technology Industries Association).
- Playback on other equipment of images recorded using your camera and playback on your camera of images recorded or edited using other equipment are not guaranteed.

Design and specifications are subject to change without notice.

Battery charger/Battery**BC-VM10A Battery charger**

Input rating	100 V - 240 V AC, 50/60 Hz, 9 W
Output rating	DC 8.4 V, 0.75 A
Operating temperature range	0°C to 40°C (32°F to 104°F)
Storage temperature range	-20°C to +60°C (-4°F to +140°F)
Maximum dimensions	Approx. 70 mm × 25 mm × 95 mm (2 7/8 inches × 1 inch × 3 3/4 inches) (W/H/D)
Mass	Approx. 90 g (3.2 oz)

Rechargeable battery pack NP-FM500H

Battery	Lithium-ion battery	
Maximum voltage	DC 8.4 V	
Nominal voltage	DC 7.2 V	
Maximum charge voltage	DC 8.4 V	
Maximum charge current	2.0 A	
Capacity	Typical	11.8 Wh (1 650 mAh)
	Minimum	11.5 Wh (1 600 mAh)
Maximum dimensions	Approx. 38.2 mm × 20.5 mm × 55.6 mm (1 9/16 inches × 13/16 inches × 2 1/4 inches) (W/H/D)	
Mass	Approx. 78 g (2.8 oz)	

Lens

Name (Model name)	DT 18-55mm F3.5-5.6 SAM II (SAL18552)	DT 55-200mm F4-5.6 SAM (SAL55200-2)	DT 18-135mm F3.5-5.6 SAM (SAL18135)
Equivalent 35mm-format focal length* (mm)	27–82.5	82.5–300	27–202.5
Lens groups-elements	7–8	9–13	11–14
Angle of view*	76°-29°	29°-8°	76°-12°
Minimum focus** (m (feet))	0.25 (0.82)	0.95 (3.2)	0.45 (1.48)
Maximum magnification (X)	0.34	0.29	0.25
Minimum f-stop	f/22-36	f/32-45	f/22-36
Filter diameter (mm)	55	55	62
Dimensions (maximum diameter × height) (approx., mm (in.))	71.6×69 (2 7/8 × 2 3/4)	71.5×85 (2 7/8 × 3 3/8)	76×86 (3 × 3 1/2)
Mass (approx., g (oz.))	222 (7 7/8)	305 (10 3/4)	398 (14)

* The values for equivalent 35mm-format focal length and angle of view are based on an Interchangeable Lens Digital Camera equipped with an APS-C sized image sensor.

** Minimum focus is the shortest distance from the image sensor to the subject.



- This lens is equipped with a distance encoder. The distance encoder allows more accurate measurement (ADI) by using a flash for ADI.
- Depending on the lens mechanism, the focal length may change with any change in the shooting distance. The focal length assumes that the lens is focused at infinity.
- The infinity position provides for some adjustment to compensate for focus shift caused by changes in temperature. To shoot a subject at infinite distance in MF mode, use the viewfinder and set focus.

On focal length

The picture angle of this camera is narrower than that of a 35 mm-format camera. You can find the approximate equivalent of the focal length of a 35 mm-format camera and shoot with the same picture angle by increasing the focal length of your lens by half.

For example, by using a 50 mm lens, you can get the approximate equivalent of a 75 mm lens on a 35 mm-format camera.

Trademarks

- **α** is a trademark of Sony Corporation.
- “Memory Stick,” , “Memory Stick PRO,” **MEMORY STICK PRO**, “Memory Stick Duo,” **MEMORY STICK DUO**, “Memory Stick PRO Duo,” **MEMORY STICK PRO DUO**, “Memory Stick PRO-HG Duo,” **MEMORY STICK PRO-HG DUO**, “Memory Stick XC-HG Duo,” **MEMORY STICK XC-HG DUO**, “Memory Stick Micro,” “MagicGate,” and **MAGICGATE** are trademarks of Sony Corporation.
- “InfoLITHIUM” is a trademark of Sony Corporation.
- “PhotoTV HD” is a trademark of Sony Corporation.
- “AVCHD” and “AVCHD” logotype are trademarks of Panasonic Corporation and Sony Corporation.
- Blu-ray Disc™ and Blu-ray™ are trademarks of the Blu-ray Disc Association.
- Dolby and the double-D symbol are trademarks of Dolby Laboratories.
- Microsoft, Windows, DirectX, and Windows Vista are either registered trademarks or trademarks of Microsoft Corporation in the United States and/or other countries.
- The terms HDMI and HDMI High-Definition Multimedia Interface, and the HDMI Logo are trademarks or registered trademarks of HDMI Licensing LLC in the United States and other countries.
- Mac and Mac OS are trademarks or registered trademarks of Apple Inc.
- Intel, Intel Core, MMX, and Pentium are trademarks or registered trademarks of Intel Corporation.
- SDXC Logo is a trademark of SD-3C, LLC.
- Eye-Fi is a trademark of Eye-Fi Inc.
- “” and “PlayStation” are registered trademarks of Sony Computer Entertainment Inc.
- Adobe is a registered trademark or a trademark of Adobe Systems Incorporated in the United States and/or other countries.
- Facebook and the “f” logo are trademarks or registered trademarks of Facebook, Inc.
- YouTube and the YouTube logo are trademarks or registered trademarks of Google Inc.
- In addition, system and product names used in this manual are, in general, trademarks or registered trademarks of their respective developers or manufacturers. However, the™ or® marks are not used in all cases in this manual.



- Add further enjoyment with your PlayStation 3 by downloading the application for PlayStation 3 from PlayStation Store (where available.)

- The application for PlayStation 3 requires PlayStation Network account and application download. Accessible in areas where the PlayStation Store is available.



Index

A

AEL w/ shutter	56
AF area	53
AF Illuminator	56
AF Track. Duration	56
Aperture Priority	36
Area Setting	28
Aspect Ratio	55
Audio Recording	57
Audio signals	61
Auto Object Framing	53
Auto Review	57
Autoflash	42
Autofocus Mode	53

B

Battery pack	19, 21
Beep sound (Audio signals)	61
Bracket: Cont.	45

C

Charging battery pack	19
Cleaning Mode	61
Clear Image Zoom	55
Color Space	56
Computer	66
Cont. Shooting	45
Control button	51
Creative Style	54
CTRL FOR HDMI	61

D

Date/Time Setup	27
DC IN terminal	16
Delete	34

Demo Mode	61
Digital Zoom	55
Diopter-adjustment	29
Disc creation	69
DISP	46
DISP Button(Finder)	57
DISP Button(Monitor)	57
Display	46
Display All Info.	46
Display Card Space	60
Drive Mode	45
DRO/Auto HDR	54

E

e-Front Curtain Shutter	59
Enlarged image	48
EV scale	43
Exposure compensation	43
Eyepiece sensor	14
Eye-Start AF	57

F

Face Registration	59
File Format	56
File Number	60
Fill-flash	42
FINDER/LCD Setting	57
Flash Comp.	53
Flash control	56
Flash Mode	41, 75
Flash Off	30, 42
Fn	51, 53
Focal length	87
Focus hold	58
Focus Hold Button	58
Folder Name	60

- Format 60
 Func. of AEL button 58
 Function button 52, 53
- G**
- Graphic Display 46
 Grid Line 57
- H**
- Handbook 76
 Hand-held Twilight 38
 HDMI 50
 HDMI Resolution 61
 High ISO NR 56
- I**
- Image Data Converter 65, 67
 Image Index 49
 Image Size 47
 In-Camera Guide 62
 Index 49
 Initialize 61
 Install 66
 Intelligent Auto 30
 ISO 53
 ISO Button 58
- L**
- Landscape 38
 Language 61
 LCD Brightness 60
 LCD screen 35, 71
 Lens 18, 24
 Lens Comp.: Chro. Aber. 58
 Lens Comp.: Distortion 59
 Lens Comp.: Shading 58
 Live View Display 58
 Lock-on AF 53
- Long Exposure NR 56
- M**
- Mac 67
 Macro 38
 Manual Exposure 36
 Memory card 21
 MENU 55
 Menu 55
 Menu start 60
 Metering Mode 53
 Microphone jack 16
 Mode Dial Guide 60
 MOVIE 32
 Movie 32
 MOVIE Button 58
 Multi interface shoe 15
- N**
- New Folder 60
 Night Portrait 38
 Night Scene 38
 No Disp. Info 46
 Number of recordable
 images 77, 78
- P**
- Panorama: Direction 55
 Panorama: Size 47
 Peaking Color 58
 Peaking Level 58
 Picture Effect 54
 Playback Display 59
 PlayMemories Home 64, 66
 Portrait 38
 Power Save 61
 Power Saving Start Time 61
 Pressing halfway down 31
 Preview Button 58

- Program Auto36
 Protect.....59
- Q**
- Quality55
- R**
- Rear Sync.....42
 Record Setting56
 Recording information display ...46
 Recording movies32
 Recover Image DB60
 Red Eye Reduction57
 Release w/o Lens57
 Remaining battery level.....23
 Remote Camera Control68
- S**
- S. Auto Cont. Shooting.....57
 S. Auto Image Extract.57
 Scene Selection.....38
 SCN38
 Select REC Folder60
 Self-timer.....45
 Setting the clock27
 Shooting.....30
 Shooting mode.....36
 Shooting Tip List.....63
 Shooting Tips.....62
 Shoulder strap16
 Shutter Priority36
 Single Bracket45
 Single Shooting45
 Slide Show59
 SLOW SYNC42
 Slow Sync.....42
 Smile/Face Detect.....53
 Software.....64
- Specifications..... 81
 Specify Printing 59
 Sports Action 38
 SteadyShot 56
 Still/Movie Select 59
 Strap..... 16
 Sunset..... 38
 Superior Auto..... 37
 Sweep Panorama..... 39
- T**
- T8..... 40
 Tele-zoom Cont. Priority AE.... 40
 Time zone 28
- U**
- Upload Settings..... 61
 USB Connection 61, 68
 USB LUN Setting..... 61
- V**
- Version..... 61
 View Mode 59
 Viewfinder Bright 60
 Viewfinder Color Temp..... 60
 Viewing image..... 33
 Viewing images on a TV
 screen..... 50
 Volume Settings..... 59
- W**
- WB bracket 45
 White Balance..... 54
 Wind Noise Reduct. 57
 Windows 64, 67
 Wireless 42
- Z**
- Zoom..... 30



<http://www.sony.net/SonyInfo/Support/>

Additional information on this product and answers to frequently asked questions can be found at our Customer Support Website.

<http://www.sony.net/>

Printed using VOC (Volatile Organic Compound)-free vegetable oil based ink.

